

For
TEXTILES &
APPAREL

1.8m Wide High-Speed Sublimation Transfer Inkjet Printer

Mimaki[®]

Tiger600-1800TS

*High-Speed and High-Quality
Digital Textile Printing Era Has Arrived*

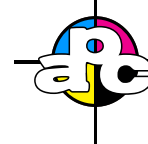

american
print consultants INC.

Authorized USA Dealer

Tiger600-1800TS

Unparalleled productivity !

Next-Generation Tiger :
Unparalleled Productivity
and Superior Image Quality

Print Speed
Max. **550m²/h**

Mimaki's original print technology and mechanism design, together with a new high-speed drive print head. The new [Tiger] was born with high productivity and image quality, setting the stage for the future of digital textile printing.

[Tiger600-1800TS] with Mimaki's accumulated technologies, embodies practical image quality and productivity for textile and fashion applications. It is a product that brings you to the world of sustainable digital textile printing.



The Mimaki's Tiger series is reborn with a maximum speed of 550 sqm/h
Embracing the digital printing era - paving the way to a sustainable textile industry

New design !

Advanced Transfer Paper Transport Mechanism :
Stable Printing even with Thin Transfer Paper!

The Tiger600-1800TS features a newly designed wrinkle-removing roller within its transport system.

Previously, transport tension-induced wrinkles on the transfer paper led to cockling, causing the print head to touch the paper.

The newly designed roller allows wrinkles to escape when transport tension is applied, effectively preventing any contact between the print head and the transfer paper.

Ensuring stable transport of thin paper helps reducing running cost.

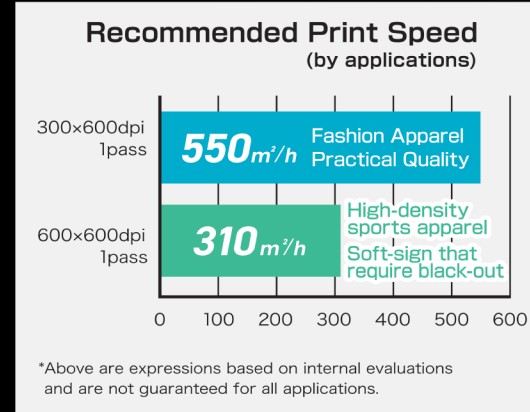
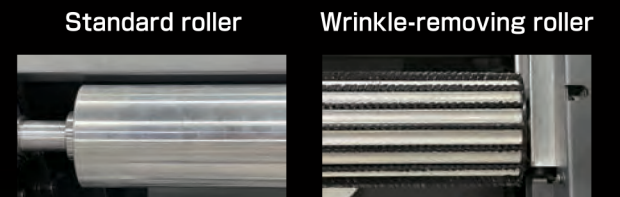
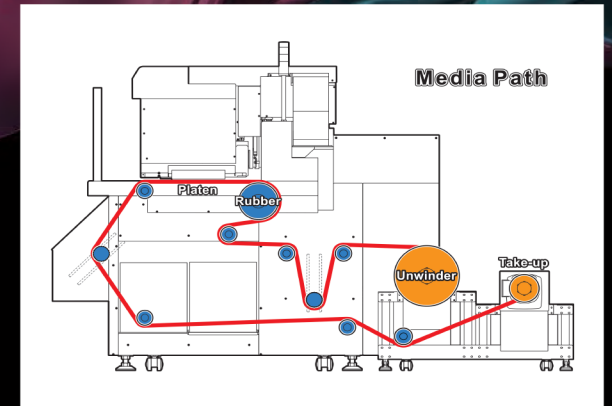

Light Curtain

Detects obstructions and halts printing to prevent accidents

Print Carriage

8-print head array achieves high productivity

Maintenance Switch

Switches Printing-mode / Maintenance-mode

Wrinkle-Removing Roller

Reduces wrinkles of transfer paper due to transport tension. Smooth transport of thin transfer paper is supported.

Dryer Unit

Placed underneath the main unit, contributes to space-saving

Take-up/Unwind Unit (Rear Section)

Transfer paper loading/unloading from one side - Significant space saving for operation

Operation Software : MPC

Printer operation and production directive performed from the touch panel.

*Please prepare a PC for RIP software (Sold separately)

10kg Ink Tank Supply Unit & Internal Buffer Tank

Ink tank can be replaced during printing operation. In addition, the ink circulation function automatically agitates the ink in the system, contributes to less maintenance time and stable operation.

NRS : Nozzle Recovery System

Even when head cleaning does not clear nozzle clog, productivity can be maintained.



*Recovery may not work depending on nozzle clog positions

Head Select Function

The print process can be continued using the available range of print heads when large number of nozzles are clogged.

*Productivity varies depending on the usable range of print heads.

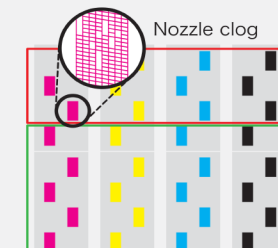

Unusable print head range

Usable print head range

Without head select



When using head select

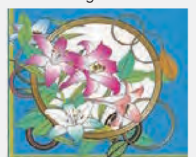

Smart design !

Space-Saving and Lightweight Design
for Easier Installation

Both transfer paper set-up and take-out can be performed from one-side

- Operation footprint reductions : Approx. 50% vs previous model
- Product weight reductions : Approx. 80% vs previous model

Greatly easing installation location restrictions
- easier for customers to install the system

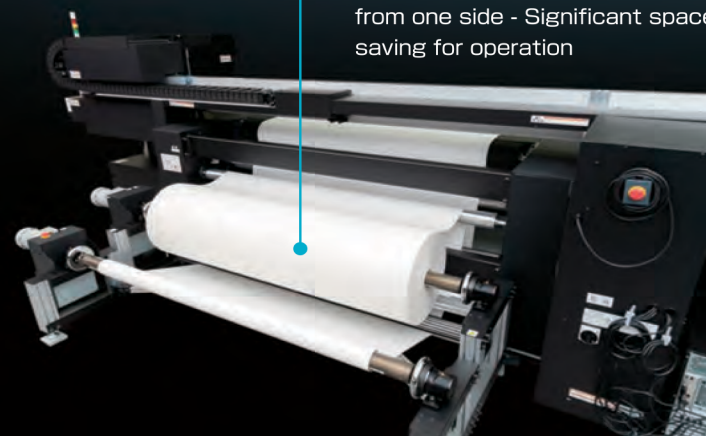

Continuous production!

Ink System Design
and Support Functions
for Continuous
and Stable Production

A new ink system design implemented to reduce the risk of nozzle dropout during operation. The system is also equipped with support functions to ensure that customers can continue working even in the event of nozzle clogging.

Shape Your Expression as Desired with Ultra-Safe Eco Sublimation Transfer Ink and Specialized Textile Software



Highly Safe Eco Sublimation Transfer Ink **MLSb510**

High density and wide color gamut MLSb510, delivers vivid and striking results

MLSb510 is also safe and environmentally friendly, boasting ECO PASSPORT certification, and is currently undergoing ZDHC MRSL Lv.3 adoption.



More Advanced Textile RIP Software
for Professional Use

TxLink4™

- Parallel RIP functionality improves work efficiency
- Smoother gradients with 16-bit rendering
- Easy nesting operation saves media, etc. Nesting functions to suit your application
- Variable data print function ideal for sportswear
- Image masking process is possible within TxLink4
- PDF transparency effects can be faithfully rendered and reproduced

Product specifications

Item		Tiger600-1800TS
Print head type		On-demand piezo print head
Number of print head		8 units (4 in-lined x 2 staggered layout)
Print resolution		300dpi, 600dpi
Maximum print width		1,850mm (72.8")
Minimum print width		210mm (8.3")
Maximum media width		1,900mm (74.8")
Paper core diameter		3 inches
Media roll diameter		600mm or less (≤ 23.6")
Media weight		300kg or less (≤ 661.4 lb.)
Ink	Type/Colors	Sublimation Transfer MLSb510 (BI/M/Y/K)
	Content	10kg Ink Tank
Interface		Ethernet 10GBASE-T USB2.0 (Removable Disk)
Operation method Operation software		Built-in touch panel Exclusive Software MPC (Mimaki Print Controller)
RIP Software		TxLink4 Standard / Professional
Compatible Standards		ETL compliant with IEC62368-1, CE marking (EMC Directive, Low Voltage Directive, Machinery Directive) CB certification / RoHS / REACH / RCM / KC certification / UKCA
Power		3ϕ 380-415V ± 5%, 50/60Hz ± 1%, 25A
Operational environment	Operation temperature	20-30 degC / 68-77 degF
	Humidity	35-65% RH (Non-condensing)
	Dust level	0.15mg/m ³ or less (Equivalent to a general office floor level)
	Maximum operating altitude	2,000m
Power consumption	Max. operating	15.0kW or less
	Standby	1.0kW or less
External dimensions (WxDxH)		5,300x2,800x1,900mm (209"x110"x75")
Weight		1,620 or less (≤3,572 lb.) ^{*1,2}

*1: Total of entire system

*2: paper and ink weight are excluded

Supply items

Item		Code	Descriptions
Sublimation Transfer Ink MLSb510	Blue	MLS51-BLT-BJ	10 kg Ink tank
	Magenta	MLS51-MT-BJ	
	Yellow	MLS51-YT-BJ	
	Black	MLS51-KT-BJ	
Maintenance liquid	ML03 bottle	ML003-Z-K1	200ml bottle

Installation space

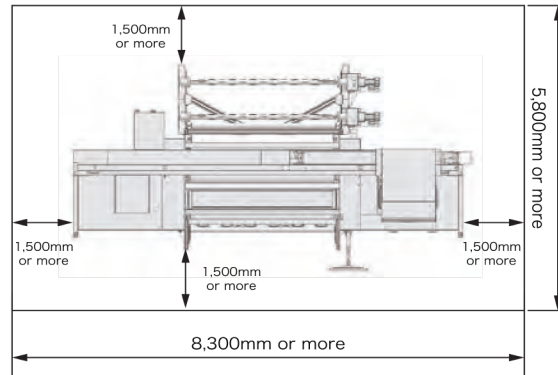

Entering within 1 meter of perimeter is extremely dangerous during the production

● Some of samples in this catalog are artificial renderings. ● Specifications, design and dimensions stated in this catalog may be subject to change without notice for technical improvements etc. ● The corporate names and merchandise names written in this catalog are the trademark or registered trademark of the respective corporations. ● Inkjet printers print using extremely fine dots, so colors may vary slightly after replacement of print heads. ● Also note that if using multiple printer units, colors could vary slightly from one unit to other (s) due to slight individual differences. ● The specifications described in this catalog are as of August 2023.



Corporate Headquarters
150 Satellite Blvd. NE, Ste. A,
Suwanee, GA 30024
Tel: 888-636-0491, 855-897-2254
www.mimakiusa.com

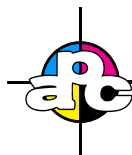

american
print consultants

Authorized USA Dealer

FIND US ON:



80 Industrial Drive
Chambersburg, PA 17201
Ph: (855) 927-2465
Visit us at www.apcink.com

MAS-BRO-EQUIP-006